



FIMI X8 MINI User Manual

Please read the user manual carefully before using and keep the manual for future reference

Services & Support

FIMI provides X8 Mini users with tutorial videos and the following information:

1. 《FIMI X8 MINI User Manual》
2. 《FIMI X8 MINI Quick Start Manual》
3. 《FIMI X8 MINI Disclaimer and Safety Operation Instructions》

Users are advised to watch tutorial videos before using the product and read FIMI X8 Mini Disclaimer and Safety Operation Instructions carefully and get to know the process of using by going through FIMI X8 Mini Quick Start Manual. For more detailed product information, please refer to FIMI X8 Mini User Manual.

Please download the firmware on the link below : <https://www.fimi.com>

4. Please scan the the following QR-code to download FIMI Mini App



Product Introduction

The FIMI X8 Mini is a high integrated and foldable drone equipped with long flight time, strong wind resistance, 250g-class ultra-light design and other advanced technologies which achieve functions like long-distance remote control, intelligent flight, precise landing, etc. The built-in 3-axis gimbal stabilizes the camera which is able to shoot 4K video at 30 fps and performs real-time image transmission. The easy-to-use APP enriches with smart features like one-tap edit, and fast connection, bring you more joyful flight trip.

Package List



Aircraft



Remote controller



Battery



Spare Propellers



Screwdriver



Gimbal Cover

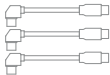

Cable



Instruction



Screws



USB-Cable

Product Overview

1 Drone

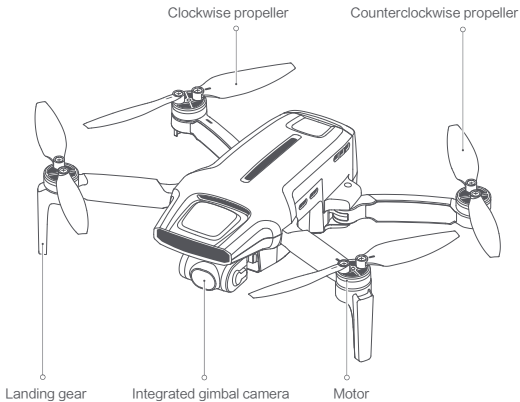

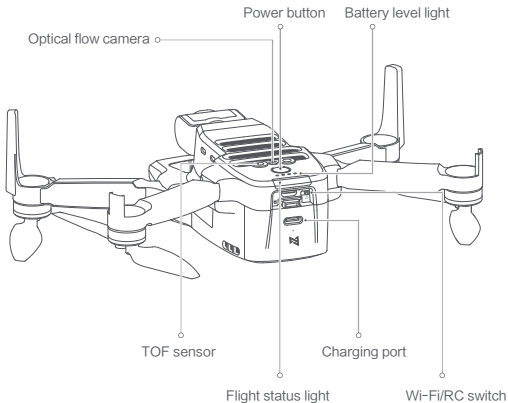

2 Remote controller

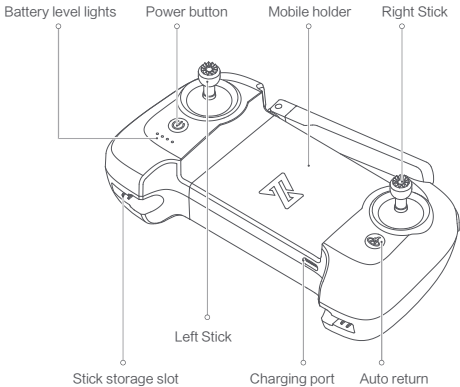

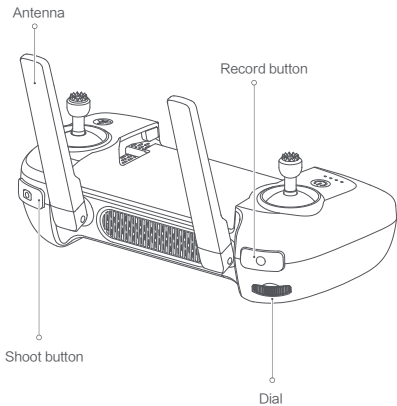

Controller Functions

| | Buttons | Function description |
|---|----------------------|--------------------------------------------------------------------------------------------------------------------------------------------------------------------------------------------------|
| 1 | Left stick | Push stick forward to ascend Pull stick backward to descend Move stick left & right to Yaw CCW Move sick right to Yaw CW |
| 2 | Right stick | Push stick forward to Pitch (fly) drone forward Pull stick backwards to Pitch (fly) drone backwards Move stick left to Roll (fly) drone left Move stick right to Roll (fly) drone right |
| 3 | RTH (Return to Home) | Long press the button for over 2 seconds, and the drone will enter RTH mode when you hear a beep. Short press the button to cancel RTH mode |
| 4 | Photo button | Short press to shoot the picture |
| 5 | Video button | Short press to start / stop recording |
| 6 | Dial | Adjust the pitch angle of gimbal camera |
| 7 | Power button | Short press to view the battery level Short press+long press 2 seconds to power on/off |

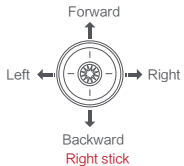
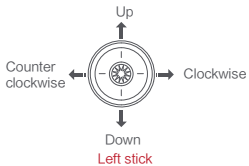
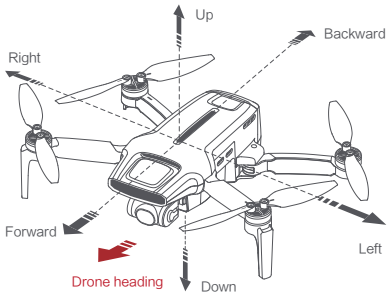

Note: The stick mode can be set in FIMI Navi Mini app. (The default is Mode 2)

Drone

Flight Mode:

GPS Mode

To achieve precise hovering, the drone is equipped with a GPS module. The intelligent flight function works in GPS mode. Users can enable Sport Mode or Beginner Mode in the flight settings. When the Beginner Mode is on, the flight speed, flight distance, flight altitude and RTH altitude will be limited. In sport mode, the maximum flight speed is 16m/s, the maximum ascending speed is 5m/s, and the maximum descending speed is 3.5m/s.

VPU Mode (Vision Processing Unit Mode)

An Optical Flow module is also built into the drone for precise hovering and landing at the home point. In VPU mode, the intelligent flight function is not supported. The maximum flight speed is 10m/s (36 km/h), the maximum ascending speed is 3m/s (11 km/h), and the maximum descending speed is 2m/s (7 km/h). When the drone is flying above a well-lit ground with a clear texture and the GPS signal is poor, it will switch automatically to VPU mode.

ATTI Mode (Altitude Mode)

When the GPS signal is poor or the compass has interference, the drone enters in ATTI mode. In this mode, the drone can start drifting horizontally and intelligent flight mode is not supported. Therefore, in case of any accidents, we recommend flying in an open area with good GPS signal reception. Once the drone enters in ATTI mode, please land in a safe place as soon as possible.

Drone Lights

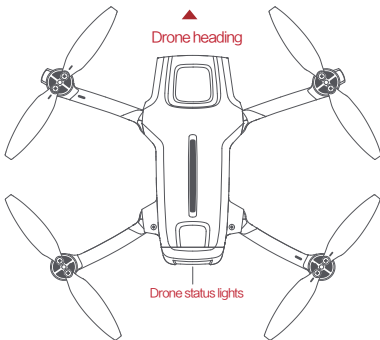

| Drone status | Light status | Drone lights |
|-----------------------------------------------------------------------|------------------------------------------------------------|-------------------------------|
| Initial check failed Compass error IMU error Cannot take off | Self-checking failed Take-off forbidden Flying error | Red lights are on |
| IMU is warmed up | Self-checking | Yellow lights fade in and out |

| | | |
|-----------------------------------|--------------------------------|-----------------------------------------------------------|
| Compass calibration | Compass calibrating | Horizontal green light is on and vertical red light is on |
| Compass needs to be calibrated | Compass needs to be calibrated | The red and yellow light is flashing at regular intervals |
| The drone disconnects with the RC | Signal is lost | Yellow lights fade in and out |
| Low battery warning | Low battery | Red lights flash quickly |
| Extremely low battery warning | Extremely low battery | Red lights double flash |
| Take off as normal | Take off | Green lights fade in and out |
| ATTI mode | ATTI mode | Red lights are on |
| Firmware update | Firmware update | The red and green light flash at regular intervals. |
| Directly connect with the phone | Connecting | Status light flashes in turn |
| Disconnect with the phone | Signal lost | Yellow lights fade in and out |
| Pairing | Pairing | Tail lights turned off |

Safety Protection

Failsafe Return

Failsafe return is only supported in GPS mode. When the drone and remote controller signal is interrupted for more than 2 seconds, the flight control system built into the drone will take over the control of your drone, plan the return path according to the original flight path, then the drone will fly back and land at the home point. This function works precisely if enough GPS satellites are locked, the compass has no interference and the home point has been recorded correctly. If the wireless signal reconnects during the failsafe return, the pilot can short press the RTH button to cancel, and the drone will hover at the current position.

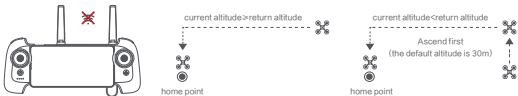

Low-power Protection

In flight, when the battery level is only enough for RTH, App advises users to return, and the drone will return automatically after 10 seconds countdown. When the battery level is only enough for landing, App advises users to land as soon as possible, and the drone will land automatically after 10 seconds countdown. When the battery level is at 15% usage left, the drone will be forced to land.

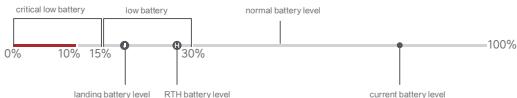

Hovering on the Edge of No-fly-zone

The drone will automatically hover in the restricted flight area designated by the state, such as the edge of airports, and the App will appear corresponding hints. The user can use sticks to fly the drone from the edge of the no-fly-zone, but the drone will not enter the no-fly-zone.



Intelligent Flight

Auto Take-off

When the conditions are right, tap the auto take-off icon on the left side of the APP interface. In GPS mode, the drone will take off to an altitude of 4 meters and hover for sticks control. In VPU mode, the drone will take off to an altitude of 1.2 meters and hover for sticks control.

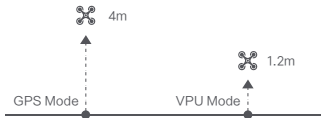

Auto Landing

When the conditions are right, tap the auto landing icon on the left side of the APP interface.

Note: Users can short press the RTH button to exit intelligent flight.

Auto Return

When the drone is in flight, the user can long press the auto return button to return the drone. When the return distance is less than 10 meters and flight altitude is less than 3 meters, the drone will ascend to 3 meters first and return to the home point; if the flight altitude is greater than or equal to 3 meters, the drone will directly return to the home point.

When the return distance of the drone is greater than or equal to 10 meters and the flight altitude is less than 30 meters, the drone will ascend to 30 meters and return to the home point; if the flight altitude is 30 meters or more, the drone will directly return to the home point. The user can press the Auto Return button or tap the APP to the left to exit.

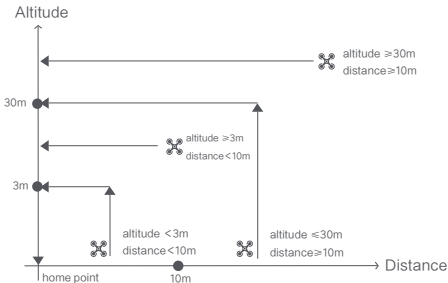

Smart Track

Smart Track is supported only in GPS mode. The user can choose Trace, Profile, or Lock in the App menu. The drone will trace the subject chosen at the App interface at a distance.

In Trace mode, the heading will always lock at the target and trace it from the back at a distance.



In Profile mode, the heading will always lock at the target and trace it from the side at a distance.

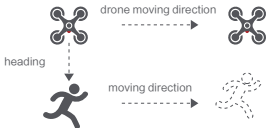

In Lock mode, the drone will hover at a place if flight speed is 0, following the target 360°. The user can also adjust flight speed, and the drone will fly around the target at a certain distance.

flight speed = 0m/s

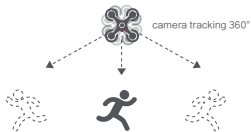

flight speed = 0m/s

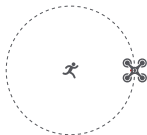

Note: In Smart Trace, users should always make sure to avoid people, animals and obstacles in the tracking path to ensure the flight safety. Users should comply with local laws and regulations when using the function.

Spiral flight

The user selects spiral flight on app, set the center point and radius. The drone will fly around the center point at a default speed. If the user sets a POI, the drone will lock and shoot the POI. Fly away from the central point to set radius. Set flight speed, move direction and heading. If the heading is free, the user can drag a rectangle around a POI

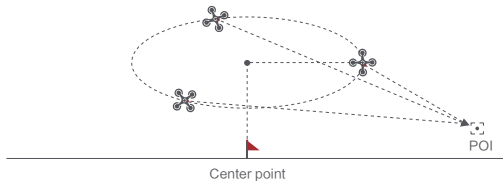

If sticks are moved in flight, the flight altitude or radius will be changed.
 Taking Mode 2 as example:



Tap-fly

The user can select Tap-fly in the App. Tap map to choose a destination and set flight speed, the drone will fly over there at a default speed in a straight line. If a point of interest is set, the camera will be locked at the POI

- Tap the map to choose a destination
- Switch to image interface to drag a rectangle around the POI
- Set flight altitude and speed

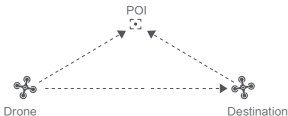

Course Lock

The user can select Course Lock mode in the App. The drone saves current fly direction as heading. The user can control sticks to adjust direction of head and gimbal, but the forward direction remains unchanged.

Tripod Mode

The max speed of the drone is 1m/s, and the max rotation speed is 60°/s. In Tripod Mode, operation sensitivity is lowered simultaneously to shoot more stable and smooth video.

Aerial Mode

The brake distance is lengthened and the angular speed of rotation is limited to make sure the shooting videos are more stable and smooth

Note: Course Lock is enabled in Aerial Mode, Users can turn it on in the APP

Spiral Mode

The user can select Spiral Mode in the App. Set the central point and radius, the drone will spirally fly upward and shoot a video simultaneously, showing a sense of space.

- Fly to a point to set as the central point.
- Fly away the central point to set radius.
- Set spiral direction and flight distance to start and shoot a video at the same time.
- The mission interrupted if the user moves sticks.

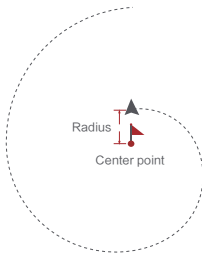

One-click Video

- Soaring flight: Select a target and the drone will rise quickly according to the set altitude, and shoot a video.
- Dronie flight: Select a shooting target, the aircraft will automatically rise and fly far away according to the set distance and current gimbal angle, and shoot a video.
- Orbit flight: Select the target, the aircraft will keep the current altitude, take the horizontal distance from the target as the radius, circle the target, and shoot a video.
- Spiral flight: Select the shooting target, the aircraft will take the top of the target as the center, and the horizontal distance from the target as the radius of the inner circle, according to the set radius difference, to spiral around the center point for a uniform speed and shoot a video.

One-tap Edit

1. One-tap edit video material as a 15-second short video. 5 templates and filters are available.
2. Save the edited video.
3. Share the work to Youtube, Facebook and Twitter.

Waypoint

Choosing waypoint and drawing route both are available at map. The drone flies along waypoint route at a default speed. If a point of interest is set, the camera will be locked at the POI. The user can select a way to set waypoints, including choosing points in flight or on the map, historical routes.

Choosing points in flight:

1. Control the drone to a point to set as a waypoint.
2. Using sticks to set flight altitude and heading direction, dials to set gimbal angle, and actions when reaching the waypoint.

3. When all waypoints ready, please set waypoints routes attribute, including flight speed, heading direction, action at the destination.
4. POI is enabled when executing waypoints.

Choosing points on the map

1. Tap map to add waypoint.
2. Set waypoint attribute, including flight altitude and action at the destination.
3. Drag the POI icon to the map, and set its altitude and relate waypoints.
4. when all waypoints ready, please set flight speed, failsafe action, and action at the destination.
5. POI is enabled when executing waypoints.

Historical routes

1. Preview the waypoints and its attribute on "Favorite" after entering the "History" list.
2. Tap to start and show the real-time waypoints trace.
3. The drone fly as the historical route after taking off.

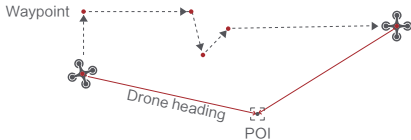

SAR Mode

The user can select SAR Mode in the APP. With real-time GPS coordinates, the drone could help user to search and rescue.

Image interface: show real-time coordinate and time of the drone, support digital zoom, screen shots to share it online

Map interface: show real-time coordinate and time of the drone in ordinary map and satellite map, screen shots to share it online

Precise Landing

In the process of Return to Home, the optical flow sensor will match landing pad features above the home point. Once matched successfully, the drone will land on the landing pad precisely.

Note: Please enable precise landing in the app before use it.

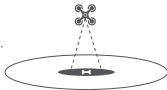

Fix-wing Mode

In Fix-wing Mode, the drone can only fly forward, not backward. The user can use sticks to control flight speed and course as showed below (Mode 2).

| | | |
|-------------|---------------|------------|
| Left stick | push upward | up |
| | Push downward | down |
| | toggle left | turn left |
| | toggle right | turn right |
| Right stick | push upward | accelerate |
| | push downward | decelerate |
| | toggle left | turn left |
| | toggle right | turn right |

Propellers

- Please install and remove propellers as the picture shown.
- Attach the gray marked propellers to the motor mounting base with gray marks on the arms.
- Distinguish clockwise propellers and counterclockwise propellers before installation.
- Need to use a screwdriver for installation and make sure screws are locked well.

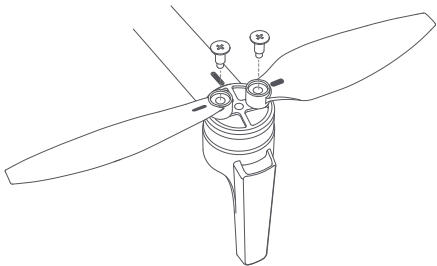

Battery

- Hardly push the battery, after the battery installed in place, there will be a "click" sound.
- To remove the battery, you need to press the bottom buckle to pull out the battery.

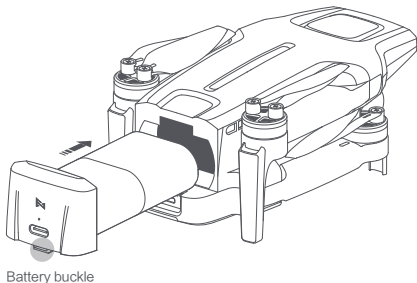

Safety tips: Please place the battery separately if don't use it for a long time.

Charging

- Use the USB cable to charge the battery as shown below.
- The battery status light keeps on when charging.
- The battery level light off when charging finished.
- It takes 2.5h to fully charge the battery via 5V/2A, 1.5h via 9V/2A and 1h via 9V/3A.

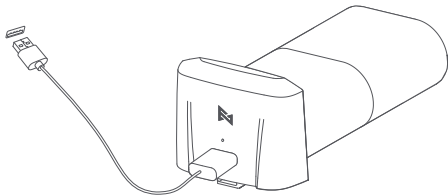

Note:

1. The power of charger affects the charging time. For ensuring the charging time, please use charger with protocol of QC2.0 and above. PD protocol fast charging is not supported.
2. Charging temperature ranges from 5°C~40°C. The battery can't be charged if temperature higher or below this range

Turning on and off

- Short press+long press power button 2 seconds to power on/off .
- Short press the power button to check battery level.
- Please check Wi-Fi/RC toggle before turning on the drone. It is supposed to restart the drone if switch the Wi-Fi/RC status.

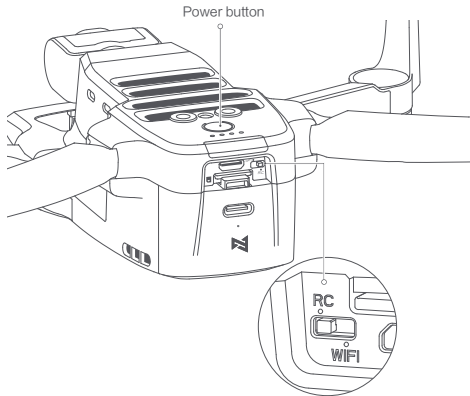

Insert Micro SD card

- When installing Micro SD card, please pull out the battery.
- Insert the SD card into the SD card slot.
- When removing SD card, press the SD card to pop out.

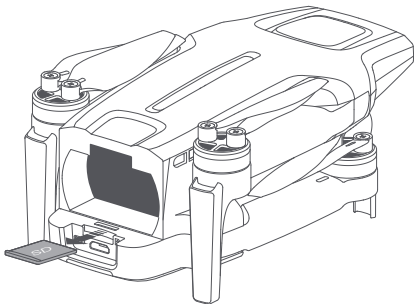

Equip and remove the gimbal protector

- Equip and remove the gimbal protector as shown

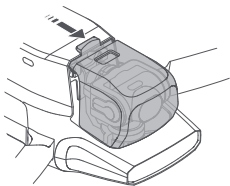

Equip the gimbal protector as the arrow leading

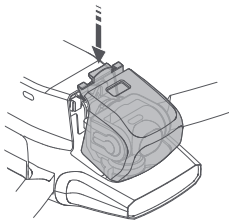

Remove the gimbal protector as the arrow leading

Gimbal

FIMI X8 MINI combines a light weight 3-axis mechanical gimbal with the latest professional control algorithms and $\pm 0.005^\circ$ control accuracy, which provides a stable shooting platform for camera. The pitch axis, default to tilt from 10° to -90° , can be adjusted by left dial of remote controller or App. The camera is equipped with 1/2.6 inches CMOS sensor, 12M pixels and 26mm focal length.

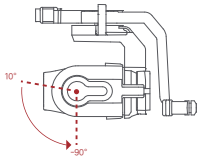

Working Mode

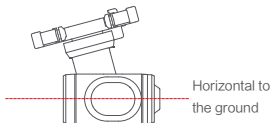

Follow:

The angle between the gimbal's orientation and aircraft front remains constant at all times.

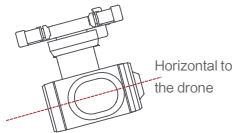

FPV mode:

The gimbal synchronizes with the movement of the aircraft to provide a first-person flying experience.

Remote controller

1 Turning on and off

- Short press+long press power button 2 seconds to power on/off.
- Short press to check battery level.

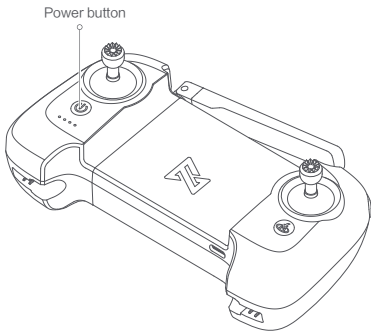

2 Charging

- Connect the remote controller to a power adapter as shown below.
- When the RC is in charge, the battery level lights are flashing.
- When the RC is fully charged, the battery level lights go out.
- It takes about 2.5 hours to fully charge the RC in the powered off condition.

5V \equiv 2A

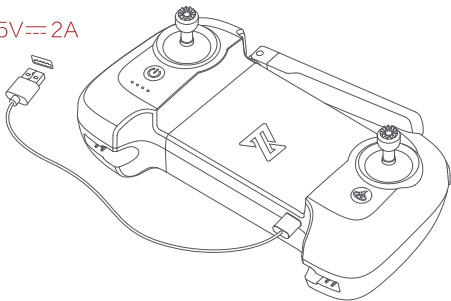

3 Connect the remote controller

- Use USB cable to connect the device as shown.
- Unfold the RC to place the device.

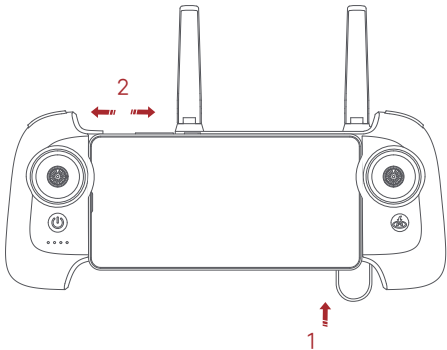

4 Taking Videos & Photos

- Press the shoot button to take a photo. A photo is taken when you hear 2 short sounds.
- Press the record button to record video. Recording starts when you hear 2 short sounds. Press again to stop recording with 4 short sounds.
- The pitch angle of the gimbal can be controlled by toggling the left dial up and down.

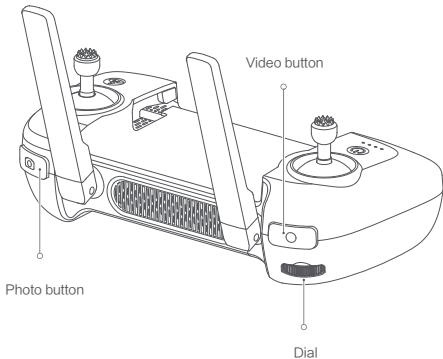

5 Sticks Control

(Mode 1)

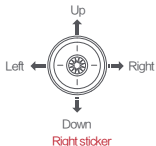
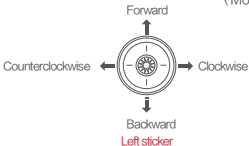

(Mode 2)

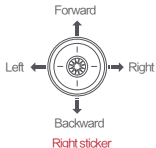
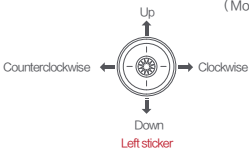

(Mode 3)

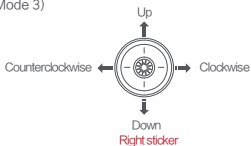
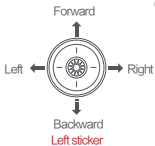

Remote Controller Pairing

When a new remote controller or drone is replaced, please pair the remote controller and the drone again as shown below:

- Turn on the drone and remote controller.
- Wait for 10 seconds, then long press the power button of controller until hearing the beep sound, and the light will be flashing.
- Long press the power button of the drone till the tail light off.
- The code pairing succeeds when the power button on the RC turns white and the tail light on the drone keeps on.

Long press the power button.

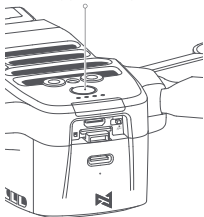

Long press the power button.

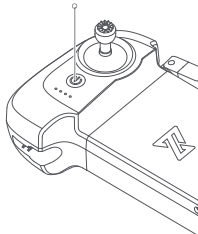





















Note:

1. Please ensure the drone and the RC stay within 0.5m while pairing.
2. Ensure the battery level of drone and RC are more than 10%.

Light status of remote controller

| Remote lights | Remote status |
|------------------------------|----------------------------------|
| Short press the power button | Check battery level |
| Fade in and out | Not connected to the drone |
| Flash in turn | Pairing or updating the firmware |
| Light keeps on | Connection normal |

| LED1 | LED2 | LED3 | LED4 | Battery level |
|----------------------------------------------------------------------------------|-----------------------------------------------------------------------------------|-----------------------------------------------------------------------------------|-----------------------------------------------------------------------------------|------------------------------------------------------------------------------|
|  |  |  |  | $75\% < \text{Battery level} \leq 100\%$ |
|  |  |  |  | $50\% < \text{Battery level} \leq 74\%$ |
|  |  |  |  | $25\% < \text{Battery level} \leq 49\%$ |
|  |  |  |  | $10\% < \text{Battery level} \leq 24\%$ |
|  |  |  |  | The remote controller beeps to warn that the battery level is less than 10%. |

APP

Download and install Fimi Navi Mini app, register a FIMI user account or enter the app directly.

Note: You are supposed to register and log in for enjoying more special flight modes.

Image Interface







1. .Return to login interface





 : Tap to return to the home screen.

2. Real-time parameter







In Flight: Show the real-time status of the drone.

-  : Height from the home point.
-  : Distance from the home point.
-  : Vertical speed of aircraft.
-  : Horizontal speed of aircraft.
-  : Battery level is only enough for landing.











3.Signal status, battery status and default settings

-  : Display the current GPS signals. 0-6 means low signal and displays in red colour, 7-12 medium signal and in yellow colour, more than 13 great signal and in white colour.
-  : Display RC signal. Tap to enter the RC setting.
-  : Display video transmission signal.
-  : Display real-time battery level. Tap to enter battery setting.
-  : Tap to enter setting.





4.Camera

-  : Switch camera mode.
-  : Tap to start recording video.
-  : Tap to start shooting photos.
-  : Tap to shoot one-tap video.
-  : Tap to choose from photo mode, video mode, one-tap video and smart flight mode.
-  : Tap to preview captured photos and videos.

5.Smart flight

-  : Switch various switch modes from waypoint mode, spiral mode, route mode, tripod mode and so on.
-  : Flight planning mode includes setting POI, flight route and historical route.
-  : Smart tracking includes trace tracking, profile tracking and lock tracking.
-  : Spiral flight.
-  : Waypoint flight.
-  : SAR mode.
-  : Aerial mode.
-  : Tripod mode.
-  : Flight direction locked.
-  : Fixed wing.
-  : Time lapsed mode.

6.Gimbal and image parameter

-  : Show remaining and total storage of SD card.
-  : Camera parameter settings, tap to set EV,ISO,shutter,video or photo mode, resolution, video size, white balance, etc.
-  : Tap to show shutter parameter.
-  : Tap to show ISO parameter.
-  : Tap to show EV parameter.

△-57.3 : Display the current pitch angle of the gimbal, Long press the gimbal for more than 2 seconds to vertically downward, double-click the gimbal to return to center









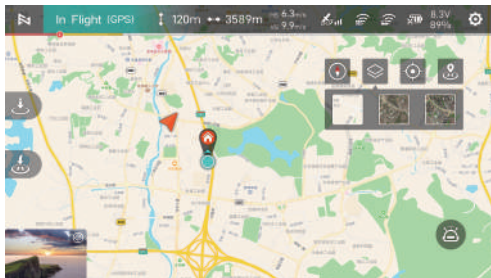



7. Light metering and locked exposure

Tap any position on the app to meter the light or lock the exposure value.



8. Map: Display the location of drone. Switch interfaces from specific map, orientation ball and guided map.

Interface of map:



-  : Tap to center the drone.
-  : Display the location of the drone.
-  : Display the location of the Home.
-  : Display the location of the phone.
-  : Tap to correct the direction.
-  : Switch the map.
-  : Home point.
-  : Tap to switch to guided map.
 -  : Represent the direction of the phone.
 -  : The position of drone to the phone. And the direction of the drone.
 -  : Compass.
 -  : Blue area means the orientation of the drone.

9.Shortcuts

-  : Tap to auto takeoff.
-  : Tap to auto land the drone.
-  : Tap to return the drone.

Wi-Fi mode connection:

1. Move the Wi-Fi/RC button to the right when the aircraft is off as shown in the figure.

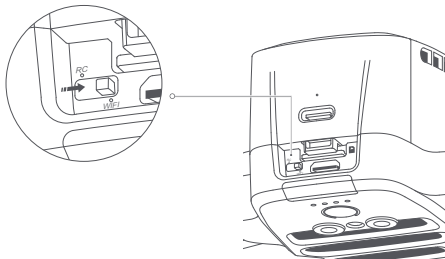

Note:

After switching the Wi-Fi mode, the remote control and the aircraft cannot be connected; if you need to use the remote control again to control, turn off the aircraft and move the Wi-Fi/RC button to the left

2. Open the APP, click "connect" in Wi-Fi mode

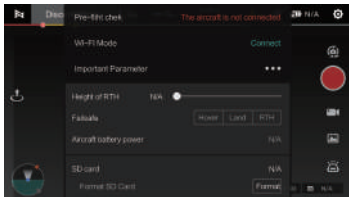

Follow the steps in the APP to display the interface after successful connection



 : Virtual key switch

 : Click the gimbal angle, the adjustment bar will pop up on the right, Long press the gimbal for more than 2 seconds to vertically downward, double-click the gimbal to return to center

Flight

Distinguish the direction of the drone

- The side of gimbal camera is head of drone.
- Distinguish the direction of drone through status light.

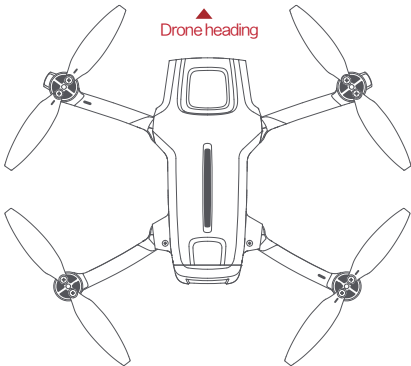

Safety tips: User should face to the tail of drone when operating it, in case of accident caused by wrong direction.

Prepare to Fly

- Make sure that the battery of the aircraft and remote controller is sufficient.
- Make sure that the propeller is properly installed and free from damage and aging.
- Make sure that the camera lens is clean.
- Make sure that the SD card is inserted.

Manual take off/land

- Keep both sticks to the bottom inner still over 3 seconds, the propellers start spinning.
- Release both sticks once propellers spinning, and firmly push the left stick upward to take off the drone.
- When the drone in flight, release the sticks and the drone will hover automatically.

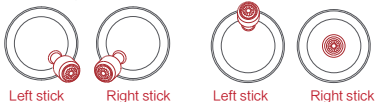

- Slowly move the left stick downward to land the drone.
- Once the drone landed, push and hold the left stick down over 5 seconds, the motors will stop.

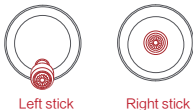

Safety tips: The drone has no waterproof function. Please be careful of landing environment. Do not land on an inclined plane for safety.

Stop propellers in an emergency

- When motors can't properly turn off, please toggle the left stick to the bottom inner in maximum range, and press Auto return-to-home button for 5 seconds simultaneously, the motors will stop.

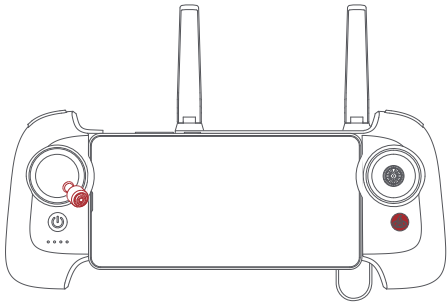

Safety tips: Do not do the operation above during normal flight to avoid motors being stopped in the air.

Flying Condition Requirement

1. The drone is suitable for people above 16 years who have full civil capacity.
2. Make sure to keep some distance from people, animals, trees, vehicles and buildings while using the drone. Please be careful when someone approaches.
3. Keep away from airports, railways, highways, high-rise buildings, utility poles and other dangerous environments when operating the drone.
4. Keep away from the areas with complex electromagnetic signals such as communication base stations and high-power antennas when operating the drone.
5. The flight altitude and distance of the drone corresponding to the take-off point will be limited based on relevant regulations and policies.
6. Do not use this product at the place and time prohibited by regulations and policies.
7. To protect the legitimate rights and interests of users, please follow the product safety instructions when using.
8. Do not operate the drone in bad weather such as strong winds, rain, snow, or fog.
9. Please operate the drone in a broad place with a good GPS signal.
10. It is suggested that user should make the first flight under the guidance of an experienced pro.

Maintenance and Calibration

Remote Controller Calibration

Please try to calibrate the remote controller when you detect inconsistencies between stick control and drone flying. Select "RC Calibration" in the remote controller menu Tap "Start" to calibrate the center, do not move sticks Skip to sticks calibration once the center calibration succeed Skip to dial calibration once the sticks calibration succeed
Note: Please turn off the power of the drone before calibrating the remote controller.

RC calibration is not available in flight

Compass Calibration

If the magnetic field changes, the compass needs to be re-calibrated to ensure flight safety. If the drone's compass needs to be calibrated, the App will give corresponding hints and guidance. After entering the flight control menu, please select "compass calibration", and then calibrate based on prompts on the App.

Note: Please connect the drone before calibration. Compass calibration is not available in flight.

Gimbal Calibration

Click "gimbal calibration" and enter the calibration page in the gimbal settings menu. After the drone is placed smoothly, click to start calibration. Do not move the drone during the calibration process. After the calibration is completed, the App interface shows "Calibration succeed". If the App interface shows "Calibration failed", please recalibrate.

Note: Gimbal calibration is not available in flight.

Propellers Maintenance

Propellers are wearing parts. When they're damaged, replace them in time to ensure flight safety and efficiency.

Battery Maintenance

Do not throw the battery into fire; Do not batter the battery; Lithium battery's capacity reduces significantly in low temperature conditions. Do not use the battery when it is below 0 degrees. Do not place the battery under the burning sun.

Gimbal Maintenance

The gimbal of X8 MINI, integrated with the drone, does not need to disassemble. Please be careful not to scratch the camera when store the drone. Please keep the camera clean for better image quality.

Drone Self-check

The drone enters the self-check when the drone is powered on. If the self-check failed, App will pop up corresponding hints.

Firmware Upgrade

Please check the firmware version regularly, new version will be updated by Fimi Navi App to prompt users to update. Please download new firmware when the App is connected with the drone and remote controller

Drone Specifications

Drone

Product model: FMWRJ04A7

Max ascending speed: 5m/s

Max descending speed: 3.5m/s

Max flight speed: 16m/s

Operating temperature: 0~40°C

Suitable altitude: $\leq 4000\text{m}$

FCC ID: 2AYVYFMWRJ04A7

Operating frequency: 5.725~5.825GHz

Dimensions: 145 × 85 × 56mm (folded)

200 × 145 × 56mm (unfolded)

Satellite positioning systems:

GPS/GLONASS/BEIDOU/GALILEO

Hovering accuracy:

Vertical $\pm 0.1\text{m}$ (within TOF sensor working range)

$\pm 0.5\text{m}$ (when GPS positioning is active)

Horizontal: ± 1.5

Remote controller

Net weight: About 260g

Dimensions: 165x89x47mm

Operating frequency: 5.725~5.825GHz

Type: Rechargeable lithium battery

Battery voltage: 3500mAh

Nominal voltage: 3.7V

Input: 5V \equiv 2A

Max transmission distance: About 8000m

Operating temperature: 0~40°C

Suitable altitude: $\leq 4000\text{m}$

FCC ID: 2AYVYFMYKQ04A7

Gimbal camera

Controllable rotation range: 10° ~ -90°(Pitch)

Angular vibration range: ± 0.005°

Lens: FOV81.1°

Camera aperture: f2.0

Camera focal distance: 3.54mm

Equivalent focal distance: 26mm

Sensor: 1/2.5" CMOS

Effective pixels: 12M pixels

ISO range: 100-3200

Max video resolution:

3840 × 2160|30fps|25fps|24fps

Max bitrate: 100Mbps

File system: FAT32

Image format: JPG

Video format: MP4

Recommended SD card:

Micro SD(U3 grade and above) 8~256GB

Note:

*Remote control distance reaches to 9km (FCC) in open area and no interference. All testing and data above come from FIMI laboratory. Errors may occur in actual use because of operating and environmental changes.

Intelligent Flight Battery Plus

Type: Li-ion 2S

Weight: 106g

Capacity: 3100mAh

Voltage: 7.2V

Limited voltage: 8.4V

Energy: 22.32Wh

Suitable charging temperature: 5~40°C

Intelligent Flight Battery

Type: LiPo 2S

Weight: 86g

Capacity: 2200mAh

Voltage: 7.7V

Limited voltage: 8.8V

Energy: 16.94Wh

Suitable charging temperature: 5~40°C

MTOM Statement

FIMI X8 MINI is a quadrotor drone. The Maximum Take-Off Mass (MTOM) of FIMI X8 MINI (Model: FMWRJ04A7) is 245g including the FIMI X8 MINI Intelligent Flight Battery (86 g) , propellers, and a micro SD card, which complies with C0 requirement.