



EZVIZ eLife 2K⁺

Standalone Smart Home Battery Camera

A 100% wire-free camera with up to 270 days of battery life.

The EZVIZ eLife 4MP excels at long-lasting battery life and crystal clear 2K⁺ video quality. Extremely easy in installation and powerful in action, the camera can be used at any household to provide reliable protection.



2K⁺ Resolution



Up to 270 Days*
of Battery Life
(10400 mAh)



Built-in 32 GB
eMMC storage



Color Night Vision



IP66 Weatherproof
Design



Smart Human
Motion Detection



Two-Way Talk



Active Defense



Supports
2.4 GHz Wi-Fi

H.265

H.265 Video
Compression



Customizable
Voice Alerts



Works with
EZVIZ Solar Panel
for Battery Charging



* Test results from the EZVIZ Lab under standard conditions.

Long-lasting battery life for extended peace-of-mind.

Equipped with a 10400 mAh rechargeable battery, the camera can last for up to 270 days* on one full battery charge, ensuring stable performance all day and night. It can also be connected to EZVIZ Solar Panel to get powered directly.

*Data comes from strict tests in the EZVIZ lab, under standard conditions.

*Please note that the solar panel is sold separately.

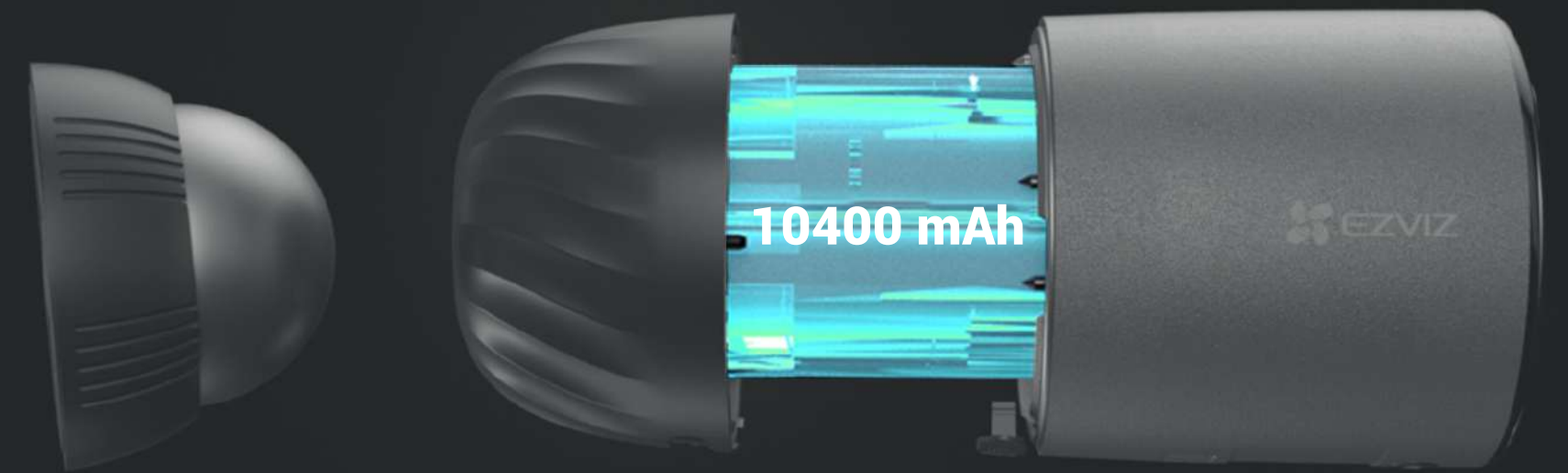

Sharper details with 2K⁺ resolution.

The camera features 2K⁺ video quality, so you see everything clearly down to every detail. It doubles the resolution of the prevailing 1080p cameras, only for enhanced visual experience.



2K⁺ Resolution

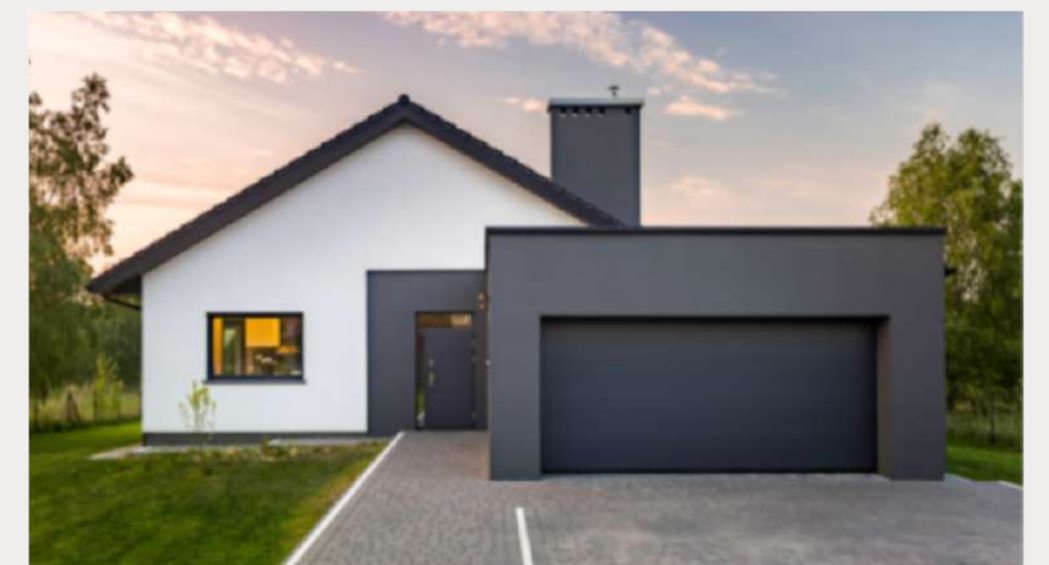

1080p Resolution

Free, secure video storage with the built-in 32 GB eMMC.

The EZVIZ eLife 2K+ is embedded with 32 GB eMMC storage capacity, which means you no longer need to go through any hassle or spend extra money on expensive storage cards. You can also choose to save your data onto the EZVIZ CloudPlay upon service subscriptions, for additional protection in case of device damage or loss.

*Cloud storage service is only available in certain markets. Please verify the availability before making any purchase.



Store 10-minute recordings per day for up to 6 months

Vivid night vision.

Thanks to two built-in spotlights, the EZVIZ eLife can render vivid color imaging even in pitch-black darkness. This allows you to see crucial details that would otherwise be lost.

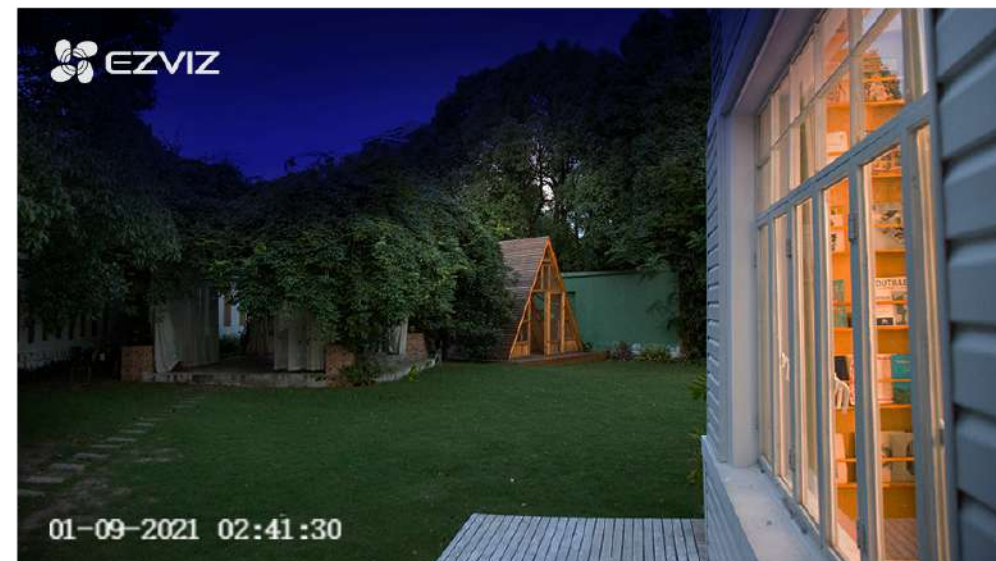

Color Night Vision



Black and White Night Vision

Motion alerts are more accurate than ever.

Integrating a PIR sensor and the person-shape detection algorithm, the EZVIZ eLife is intelligent enough to distinguish persons from other moving objects, keeping you safe while also reducing unwanted notifications.

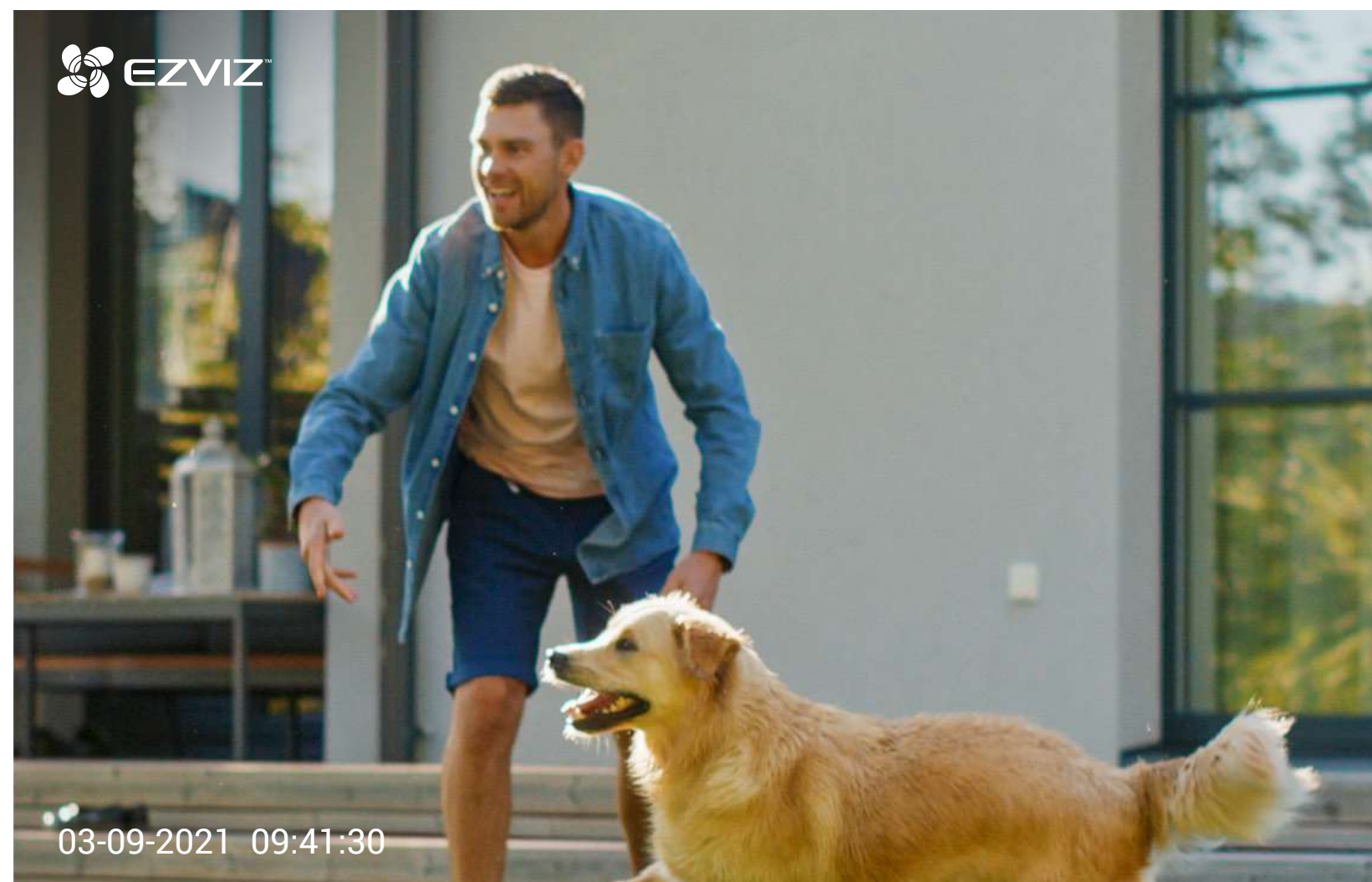

A vigilant guard over your property.

Users can set specific time frames for detection. Once the camera detects a person-shape, the EZVIZ eLife will automatically set off a siren and flash two spotlights* to let them know they have been detected.

*The spotlights will not flash when color night vision mode is enabled.

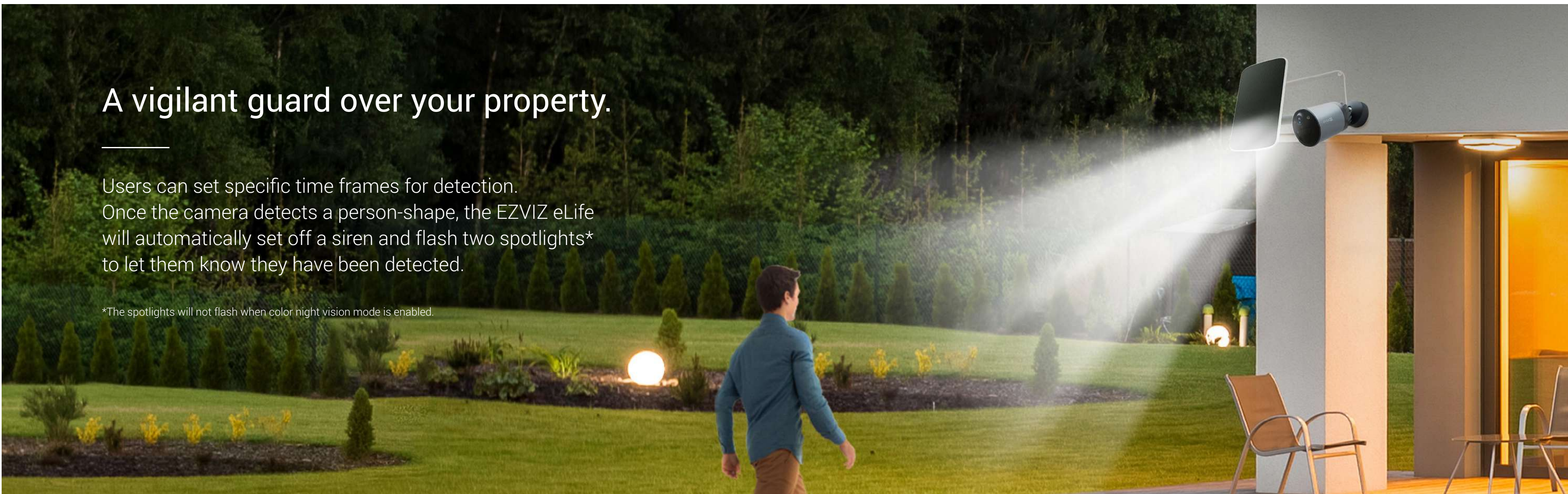

Customizable voice messages.

A thoughtful product by design, the EZVIZ eLife allows you to create unique voice messages* for greeting or deterrence.

*Supports recording three 10-second audio messages.



Easy control and two-way audio.

The camera can be easily managed via the EZVIZ App, and you can voice-enable it with "Hey Google" or "Alexa." Featuring two-way audio, you can also see, hear and talk to your visitors at anytime!



Fast and easy wire-free setup.

The camera requires zero professional help in installation. Simply attach it on any metallic surface – and it's good to go!

*Screw Base is also included as an additional installation option for you to screw the camera firmly onto the wall.

No base station needed

No wiring needed

Adjustable magnetic base



Built to last.

The EZVIZ eLife camera features an IP66 enclosure, offering high levels of protection against dust and water and delivering long-lasting protection in even the toughest weather conditions.

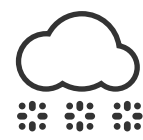
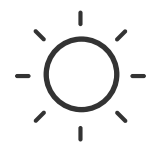

Save on storage space and reduce network loads.

The EZVIZ eLife features the advanced H.265 video compression technology, achieving same or better video quality while reducing required bandwidth and storage space*.

*When the 24/7 recording mode is applied, the H.265 technology can reduce the video storage space and bandwidth by 50% when compared to the H.264.

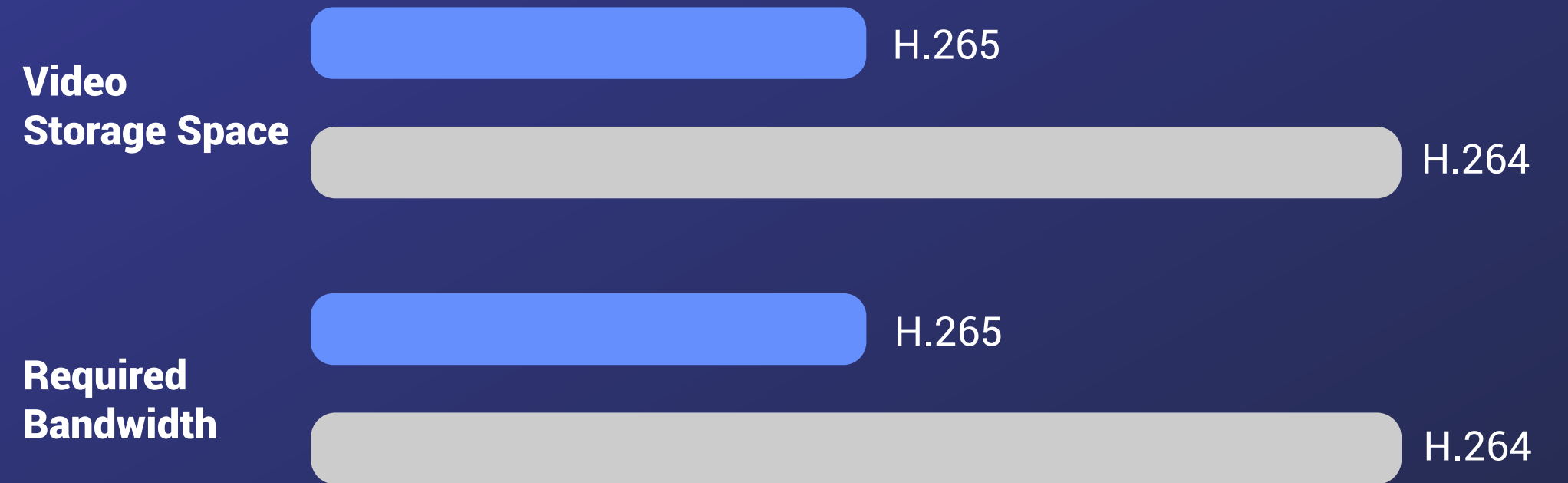

Specifications Model CS-BC1C (4MP, W1)

Camera Parameters

Image sensor	1/2.8" 4-Megapixel Progressive Scan CMOS Sensor
Minimum Illumination	0.01 Lux @ (F1.6, AGC ON), 0 Lux with IR
Shutter Speed	Self-adaptive shutter
Lens	2.8 mm @ F1.6;116° (Diagonal), 100° (Horizontal), 52° (Vertical)
Lens Mount	M12
Day & Night	IR-cut filter with auto switching
DNR	3D DNR
Night Vision	10 m / 30 ft

Video & Audio

Max Resolution	2560 × 1440
Frame Rate	15 fps. Self-adaptive during network transmission
Video Compression	H.265 / H.264
Video Bit Rate	Quad HD; HD; Standard. Adaptive bit rate.
Audio Bit Rate	Self-Adaptive
Max. Bitrate	2Mbps

Network

Wi-Fi Standard	IEEE802.11b, 802.11g, 802.11n
Frequency Range	2.4 GHz ~ 2.4835 GHz
Channel Bandwidth	Supports 20MHz
Security	64/128-bit WEP, WPA/WPA2, WPA-PSK/WPA2-PSK
Transmission Rate	11b: 11Mbps,11g: 54Mbps,11n: 72Mbps
Wi-Fi Pairing	AP pairing
Protocol	EZVIZ Cloud Proprietary Protocol
Interface Protocol	EZVIZ Cloud Proprietary Protocol
Minimum Network Requirement	2Mbps

Function

Smart Alarm	AI-powered Human Shape Detection
Two-way Talk	Supports
General Function	Anti-Flicker, Heart Beat, Password Protection, Watermark

Storage

Local Storage	Build-in 32GB eMMC Storage
Cloud Storage	EZVIZ cloud storage

Specifications Model CS-BC1C (4MP, W1)

General

Operating Conditions	-20°C to 50°C (-4°F to 122 °F), Humidity 95% or less (non-condensing)
IP Grade	IP66
Power Supply	DC 5V/2A
Battery Capacity	10400 mAh
Power Consumption	Max. 5W
Product Dimensions	104.76 × 62.80 × 62.80 mm (4.12 × 2.47 × 2.47 inch)
Packaging Dimensions	186.0 × 103.0 × 103.0 mm (7.3 × 4.0 × 4.0 inch)
Weight	Product: 365 g (12.8 oz) With Package: 835 g (28.4 oz)

In the box:

- EZVIZ eLife 2K+ Battery Camera
- Magnetic Base
- Screw Base
- Power Adapter
- USB Cable
- Mounting plate
- Drill template
- Screw Kit
- Regulatory Information
- Quick Start Guide

Certifications:

CE/FCC/WEEE/ROHS/REACH/UL

Specifications are subject to change without notice. "🌈", "EZVIZ" and other EZVIZ's trademarks and logos are the properties of EZVIZ in various jurisdictions. Other brands and product names are trademarks or registered trademarks of their respective holders.

<https://www.ezvizlife.com/>