

DH-SD22204-GC-LB

2MP 4x Starlight HDCVI PTZ Camera



- 1/2.8" 2Megapixel STARVIS™ CMOS
- Powerful 4x optical zoom
- Starlight technology
- 120 dB true WDR, 3D DNR
- Max. 25/30 fps@1080P, 25/30/50/60 fps@720P
- IP66, IK10



System Overview

Featuring with powerful optical zoom and accurate pan/tilt/zoom performance, the SD22 series PTZ camera can provide large monitoring range and great detail. The camera delivers 1080P resolution at 25/30 fps, with 4x optical zoom, and has very excellent low light performance due to the latest starlight technology. SD22 series PTZ camera is equipped with smooth control, high quality image and good protection, which makes it meet small and medium-sized video surveillance applications.

Functions

Simplicity

HDCVI technology inherits the born feature of simplicity from traditional analog surveillance system, making itself an ideal choice for investment protection. HDCVI system can seamlessly upgrade the traditional analog system without replacing existing coaxial cabling. The plug and play approach enables full HD video surveillance without the hassle of configuring network.

Starlight Technology

For challenging low-light applications, Dahua's Starlight Ultra-low Light Technology offers best-in-class light sensitivity, capturing color details in low light down to 0.005 lux. The camera uses a set of optical features to balance light throughout the scene, resulting in clear images in dark environments.

Environmental

The camera is designed for extreme temperature environments. Subjected and certified to rigorous dust and water immersion tests, the IP66 rating makes it suitable for demanding outdoor applications.

Wide Dynamic Range

The camera achieves vivid images, even in the most intense contrast lighting conditions, using industry-leading wide dynamic range (WDR) technology. For applications with both bright and low lighting conditions that change quickly, True WDR (120 dB) optimizes both the bright and dark areas of a scene at the same time to provide usable video.

HDCVI Series | DH-SD22204-GC-LB

Technical Specification

Camera

| | |
|--------------------------|---|
| Image Sensor | 1/2.8" STARVIS™ CMOS |
| Pixel | 2MP |
| Max. Resolution | 1920 (H) x 1080 (V) |
| ROM | 16 MB |
| RAM | 256 MB |
| Electronic Shutter Speed | 1/3 s–1/100000 s |
| Scanning System | Progressive |
| Min. Illumination | Color: 0.05 Lux@F1.6 B/W: 0.005 Lux@F1.6 |

Lens

| | | | | |
|----------------------|--|---------------------|--------------------|--------------------|
| Focal Length | 2.7 mm–11 mm | | | |
| Max. Aperture | F1.6–F2.7 | | | |
| Field of View | H: 112.5°–30°; V: 54.2°–19.9°; D: 122.3°–40.6° | | | |
| Optical Zoom | 4x | | | |
| Focus Control | Auto/Semi-Auto/Manual | | | |
| Close Focus Distance | 0.5 m–1 m (1.64 ft–3.28 ft) | | | |
| Iris Control | Fixed | | | |
| DORI Distance | Detect | Observe | Recognize | Identify |
| | 120 m (393.70 ft) | 48 m (157.48 ft) | 24 m (78.74 ft) | 12 m (39.37 ft) |

PTZ

| | |
|----------------------|---------------------------------------|
| Pan/Tilt Range | Pan: 0°–355° Tilt: 0°–90° |
| Manual Control Speed | Pan: 0.1°–100°/s Tilt: 0.1°–60°/s |
| Preset Speed | Pan: 100°/s; Tilt: 60°/s |
| Preset | 300 |
| Tour | 8 (up to 32 presets per tour) |
| Speed Adjustment | Support |
| Power-off Memory | Support |
| Idle Motion | Preset/Tour |
| Protocol | DH-SD Pelco-P/D (auto recognition) |

Video

| | |
|-------------------------|--|
| Resolution | 1080P (1920 × 1080); 720P (1280 × 720); D1 (704 × 576/704 × 480) |
| Frame Rate | 1080P (25/30 fps); 720P (25/30/50/60 fps) |
| CVI Product Output Mode | CVI; TVI; AHD; CVBS |
| Day/Night | Support |

| | |
|-----------------|---|
| BLC | Support |
| WDR | 120 dB |
| HLC | Support |
| White Balance | Auto/Indoor/Outdoor/Tracking/Manual/Sodium lamp/Natural/Street lamp |
| Gain Control | Auto/Manual |
| Noise Reduction | 2D/3D |
| Defog | Electronic |
| Digital Zoom | 16x |
| Flip | 0°/180° |

Certification

| | |
|----------------|---|
| Certifications | CE: EN55032/EN55024/EN50130-4 FCC: Part15 subpartB, ANSI C63.4-2014 UL: UL60950-1+CAN/CSA C22.2, No.60950-1 |
|----------------|---|

Port

| | |
|---------------|--|
| Analog Output | 1 (CVBS/CVI output, BNC port) |
| RS485 | 1 (baud rate range: 1200 bps–9600 bps) |

Power

| | |
|-------------------|-------------------|
| Power Supply | 12V DC/1.5A±10% |
| Power Consumption | 5W 6W (PTZ on) |

Environment

| | |
|-----------------------|---|
| Operating Temperature | -30°C to +60°C (-22°F to +140°F) |
| Operating Humidity | ≤ 95%RH |
| Protection | IP66; IK10; TVS 4000V lightning proof; surge protection; voltage transient protection |





Structure

| | |
|--------------|---------------------------------|
| Casing | Metal |
| Dimensions | Φ122 mm × 89 mm (4.80" × 3.50") |
| Net Weight | 0.6 kg (1.32 lb) |
| Gross Weight | 0.65 kg (1.43 lb) |

HDCVI Series | DH-SD22204-GC-LB

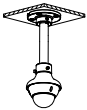
Ordering Information

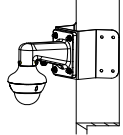
| Type | Model | Description |
|-------------|--------------------|--|
| 2M Camera | DH-SD22204-GC-LB | 2MP 4x Starlight HDCVI PTZ Camera, WDR,PAL |
| | DH-SD22204N-GC-LB | 2MP 4x Starlight HDCVI PTZ Camera, WDR, NTSC |
| | SD22204-GC-LB | 2MP 4x Starlight HDCVI PTZ Camera, WDR, PAL |
| | SD22204N-GC-LB | 2MP 4x Starlight HDCVI PTZ Camera, WDR, NTSC |
| Accessories | DC12V/1.5A | Power Adapter |
| | PFA106 | Mount Adapter |
| | PFA151 | Corner Mount Bracket |
| | PFA120 | Junction Box |
| | PFB305W | Wall Mount Bracket |
| | PFB203W | Wall Mount Bracket |
| | PFB220C | Ceiling Mount Bracket |
| | PFA150 | Pole Mount Bracket |
| PFA152-E | Pole Mount Bracket | |

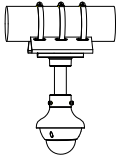
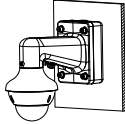
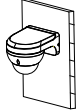
| Ceiling Mount | Ceiling Mount | Corner Mount |
|--|---|---|
| PFA106+PFB220C | | PFA106+PFB305W+PFA151 |
|  |  |  |
| Pole Mount(Vertical) | Pole Mount(Vertical) | Pole Mount(Horizontal) |
| PFA106+PFB305W+PFA150 | PFB203W+PFA152-E | PFA106+PFB220C+PFA150 |
|  |  |  |
| Wall Mount | Wall Mount | |
| PFA106+PFB305W+PFA120 | PFB203W | |
|  |  | |

Dimensions (mm[inch])

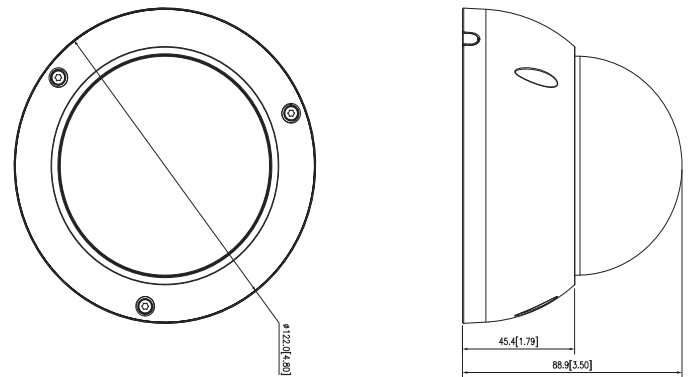

Accessories

Optional:



DC12V/1.5A
Power Adapter



PFA106
Mount Adapter



PFA151
Corner Mount Bracket



PFA120
Junction Box



PFB305W
Wall Mount Bracket



PFB203W
Wall Mount Bracket



PFB220C
Ceiling Mount Bracket



PFA150
Pole Mount Bracket



PFA152-E
Pole Mount Bracket